

AREA OF APPLICATION

- Decentral ventilation system with heat recovery
- As well for new builds as for renovation
- Installation without ducts, so perfect solution for renovation
- Continuous ventilation due to alternating ventilators
 - mechanical supply of fresh air
 - mechanical extraction of polluted air
- Optionally demand-controlled ventilation thanks to integrated air quality sensors
- High-efficiency heat recovery system for energy saving

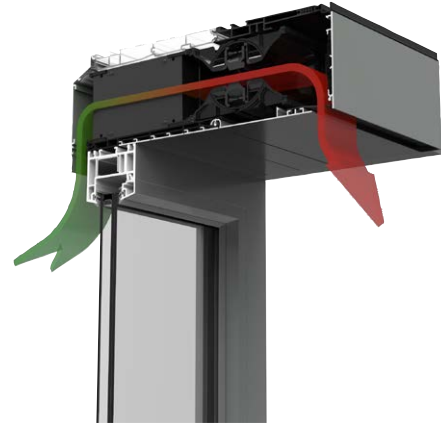

A+  40 dB(A)   61 m³/h

PRODUCT SPECIFICATIONS

- Unique regenerator [warmth recuperation]
 - Efficiency level: up to 80% [EN13141-8]
 - Regenerator module is heated by the extracted air, the warmth is saved in the regenerator and transferred to the supplied air [whenever the airflows changes direction]
- Alternating ventilation modules
 - The axial fans turn and change the airflow direction in a cyclic way.
- Frost and condensation free
 - The cyclic fans prevent condensation in the regenerator
 - The cyclic fans avoid freezing in the heat recovery system
- Automatic bypass
 - Temporarily no warmth recuperation
 - Based on integrated temperature sensors
 - Guaranteed comfort temperature inside the house
- Modular system
 - The total airflow capacity of the system is variable thanks to the possibility to change the number of the integrated fan modules [min. 2x1 module / max. 2x6 modules]
- Various air supply possibilities [supply upwards or downwards]
- Horizontal [on top of the window profile] or vertical installation [next to the window profile]

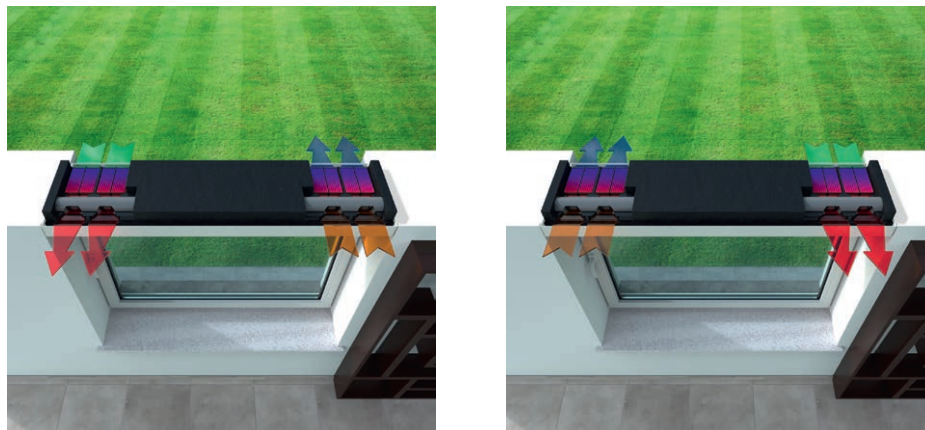

Warmth recuperation

INSTALLATION TYPES

- Available for both **horizontal installation** (on top of the window profile) and **vertical installation** (perfectly combinable with screens/roller shutters)



Endura Twist horizontally

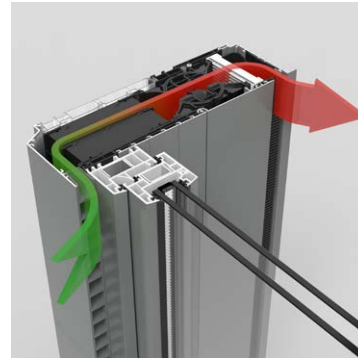

Endura Twist vertically

- Various air supply possibilities and finishes on the inside

HORIZONTAL



Air supply downwards



Air supply downwards + plastered



Air supply upwards

VERTICAL

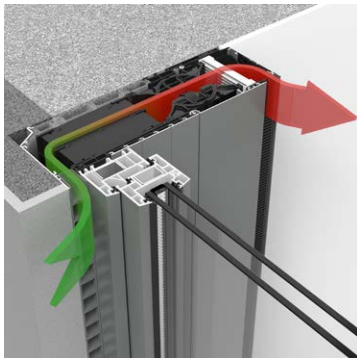

Air supply towards the window

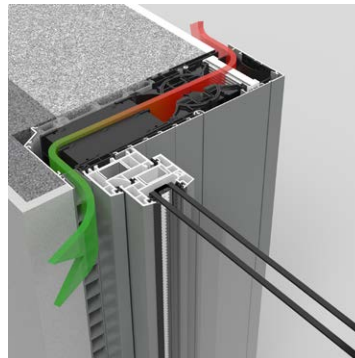

Air supply towards the wall

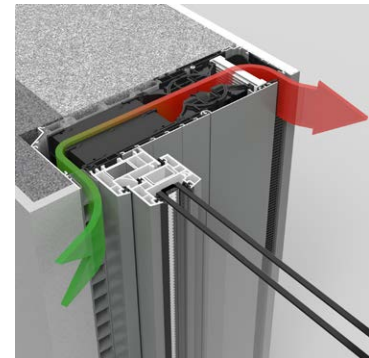

Air supply towards the window + plastered

CONTROL OPTIONS

- TouchDisplay with indication of indoor air quality and ventilation level
 - Integrated air quality sensor
 - Indication of active programm
 - 230V voltage
 - Wireless communication with ventilation module
 - Up to 5 Endura Twists can be controlled by 1 TouchDisplay
 - Filter warning + error log

- Button control
 - Power supply: button cell battery
 - Wireless communication
 - Only 1 Endura Twist can be controlled by 1 button control
 - Filter warning + error log

- Building Management System [BMS]

- Can be put on a circuit with a bathroom fan.
The Endura Twist will temporarily only supply air, until the bathroom fan is turned off.



TouchDisplay



Button control

| | TOUCHDISPLAY | BUTTON CONTROL | BMS |
|-----------------------------------|--------------|----------------|------------------------------|
| Automatic mode | • | - | • |
| Silent mode | • | • | • |
| Natural mode | • | • | • |
| Closed mode | • | • | • |
| Boost | • | • | • |
| Timers | • | - | to be implemented by oneself |
| Manual mode | • | • | • |
| Continuously alternating | - | - | • |
| Continuously not alternating | - | - | • |
| All-in | •* | •* | • |
| All-out | - | - | • |
| Demand control [CO ₂] | • | - | to be implemented by oneself |

* If a relay-circuit is provided between the Endura Twist and the bathroom fan.

Endura Twist is always controlled by a TouchDisplay OR button control OR BMS, NEVER by several control options at the same time.

FUNCTIONALITIES

- Operation:
 - Automatic (only with TouchDisplay and BMS)
 - Programmed according to time schedule with chosen level
 - Silent mode-function (device operates more quietly):
 - Very limited sound generation
 - Limited air flow capacity
 - Timers
 - Demand controlled ventilation thanks to integrated CO₂-sensor (only TouchDisplay)
 - Boost function
 - Temporary maximal ventilation
 - Duration can be set with timer
 - Natural ventilation-function:
 - Natural instead of mechanical supply and extraction, the fans stop operating.
- Closed mode:
 - Manually in case of emergency (e.g. heavily polluted air) allows you to close the fans completely. There won't be any ventilation.
 - Automatically through facade pressure compensation > 40Pa (after 30 min. the program will return to its normal program, if allowed by the weather conditions).
 - Automatically if temperature of the incoming air is too low (<5°C after warmth recuperation)
 - Guaranteed comfort
 - Device closes for 3 hours
- Manual mode (via optional Touch Display or button control)
 - Continuous ventilation on the same level
- Filter warning on control (only with optional Touch Display or button control) and device
- Dynamic facade pressure compensation
 - Activation through severe winds and large façade pressure difference.
 - Guaranteed comfort inside (no risk to over-ventilate)

MODELS

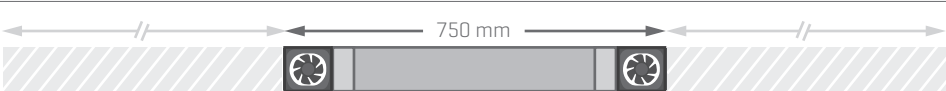
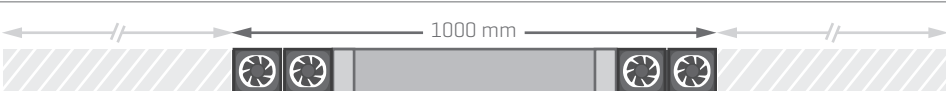
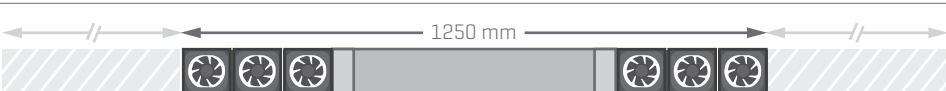
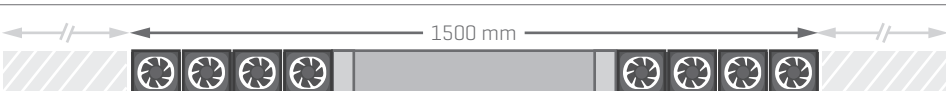
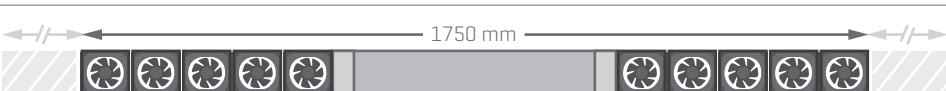
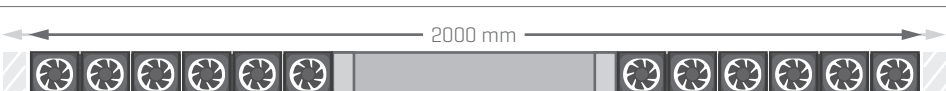
| | |
|--|--|
| Endura Twist 2x1 2 x 1 fan Q _{nom} 12 m ³ /h |  |
| Endura Twist 2x2 2 x 2 fans Q _{nom} 24 m ³ /h |  |
| Endura Twist 2x3 2 x 3 fans Q _{nom} 36 m ³ /h |  |
| Endura Twist 2x4 2 x 4 fans Q _{nom} 48 m ³ /h |  |
| Endura Twist 2x5 2 x 5 fans Q _{nom} 60 m ³ /h |  |
| Endura Twist 2x6 2 x 6 fans Q _{nom} 72 m ³ /h |  |

Q_{nom} = 50% Q_{max} with coarse 45% [G3] filter

TECHNICAL SPECIFICATIONS: without filter / with coarse 45% [G3] filter / with ePM1 75% [F7] filter

| Endura Twist | | | | | | | |
|---|--|------------|------------|------------|------------|------------|------------|
| Number of fans | | 2 x 1 | 2 x 2 | 2 x 3 | 2 x 4 | 2 x 5 | 2 x 6 |
| Without filter | Q _{min} [25%] | 6,8 m³/h | 13,5 m³/h | 20,3 m³/h | 27 m³/h | 33,8 m³/h | 40,5 m³/h |
| | Q _{nom} [50%] | 13,5 m³/h | 27 m³/h | 40,5 m³/h | 54 m³/h | 67,5 m³/h | 81 m³/h |
| | Q _{max} [100%] 13,8V | 27 m³/h | 54 m³/h | 81 m³/h | 108 m³/h | 135 m³/h | 162 m³/h |
| Coarse 45% | Q _{min} [25%] | 6 m³/h | 12 m³/h | 18 m³/h | 24 m³/h | 30 m³/h | 36 m³/h |
| | Q _{nom} [50%] | 12 m³/h | 24 m³/h | 36 m³/h | 48 m³/h | 60 m³/h | 72 m³/h |
| | Q _{max} [100%] 13,8V | 24 m³/h | 48 m³/h | 72 m³/h | 96 m³/h | 120 m³/h | 144 m³/h |
| ePM1 75% | Q _{min} [25%] | 4,9 m³/h | 9,8 m³/h | 14,7 m³/h | 19,6 m³/h | 24,5 m³/h | 29,4 m³/h |
| | Q _{nom} [50%] | 9,8 m³/h | 19,6 m³/h | 29,4 m³/h | 39,2 m³/h | 49 m³/h | 58,9 m³/h |
| | Q _{max} [100%] 13,8V | 19,6 m³/h | 39,2 m³/h | 58,8 m³/h | 78,4 m³/h | 98 m³/h | 117,7 m³/h |
| Thermal efficiency level [EN13141-8] | max. 80% | | | | | | |
| Sound reduction [ISO 10140-2] D _{n,e,w} [C;C _{tr}] in open position | 40 [0;-3] dB | | | | | | |
| Sound reduction [ISO 10140-2] D _{n,e,w} [C;C _{tr}] in closed position | 50,6 [-3;-7] dB | | | | | | |
| Sound generation [ISO 3741:2010] L _p , measured at 2 m distance from the window vent | | | | | | | |
| Without filter | Q _{min} | 18,1 dB(A) | 21,1 dB(A) | 22,8 dB(A) | 24,1 dB(A) | 25,0 dB(A) | 25,8 dB(A) |
| | Q _{nom} | 34,3 dB(A) | 37,3 dB(A) | 39,1 dB(A) | 40,3 dB(A) | 41,3 dB(A) | 42,1 dB(A) |
| | Q _{max} | 40,0 dB(A) | 43,0 dB(A) | 44,8 dB(A) | 46,0 dB(A) | 47,0 dB(A) | 47,8 dB(A) |
| Coarse 45% | Q _{min} | 18,0 dB(A) | 21,0 dB(A) | 22,8 dB(A) | 24,0 dB(A) | 25,0 dB(A) | 25,8 dB(A) |
| | Q _{nom} | 34,2 dB(A) | 37,2 dB(A) | 39,0 dB(A) | 40,2 dB(A) | 41,2 dB(A) | 42,0 dB(A) |
| | Q _{max} | 39,9 dB(A) | 42,9 dB(A) | 44,7 dB(A) | 45,9 dB(A) | 46,9 dB(A) | 47,7 dB(A) |
| ePM1 75% | Q _{min} | 19,6 dB(A) | 22,6 dB(A) | 24,4 dB(A) | 25,6 dB(A) | 26,6 dB(A) | 27,4 dB(A) |
| | Q _{nom} | 36,7 dB(A) | 39,7 dB(A) | 41,5 dB(A) | 42,7 dB(A) | 43,7 dB(A) | 44,5 dB(A) |
| | Q _{max} | 42,7 dB(A) | 45,7 dB(A) | 47,5 dB(A) | 48,7 dB(A) | 49,7 dB(A) | 50,5 dB(A) |
| Power Consumption | | | | | | | |
| Without filter | Q _{min} | 2,5 W | 3,4 W | 4,3 W | 5,2 W | 6,1 W | 7,0 W |
| | Q _{nom} | 3,1 W | 4,6 W | 6,1 W | 7,6 W | 9,1 W | 10,6 W |
| | Q _{max} | 5,2 W | 8,8 W | 12,4 W | 16,0 W | 19,6 W | 23,2 W |
| Coarse 45% | Q _{min} | 2,7 W | 3,8 W | 4,8 W | 5,9 W | 6,9 W | 8,0 W |
| | Q _{nom} | 3,6 W | 5,5 W | 7,4 W | 9,4 W | 11,3 W | 13,2 W |
| | Q _{max} | 6,0 W | 10,4 W | 14,7 W | 19,1 W | 23,4 W | 27,7 W |
| ePM1 75% | Q _{min} | 2,8 W | 3,9 W | 5,1 W | 6,2 W | 7,3 W | 8,4 W |
| | Q _{nom} | 3,7 W | 5,7 W | 7,8 W | 9,8 W | 11,8 W | 13,9 W |
| | Q _{max} | 6,2 W | 10,8 W | 15,3 W | 19,9 W | 24,4 W | 29,0 W |
| U-value [EN ISO 100077-2] | 1,0 W/m²K | | | | | | |
| Watertightness [in open position] [EN 13141-1:2004] | up to 150 Pa | | | | | | |
| Height | 110 mm | | | | | | |
| Min. width | 750 mm | 1000 mm | 1250 mm | 1500 mm | 1750 mm | 2000 mm | |
| Max. width | 6000 mm | | | | | | |
| Depth | 320 mm [345 mm incl. rain cover] | | | | | | |
| Filter | optional coarse 45% [G3] or ePM1 80% [F7] filter | | | | | | |
| Device class | I | | | | | | |
| Usable temperature-range | from -15 °C to +45 °C | | | | | | |
| Resistant to frost | yes | | | | | | |
| Condensation free | yes | | | | | | |
| Voltage | 230 V / 50 Hz | | | | | | |
| Voltage of device [internal] | 15 V DC | | | | | | |
| Supply voltage | 230 V _{AC} ± 10% | | | | | | |

PRODUCT SHEET: with coarse 45% [G3] filter / with ePM1 75% [F7] filter

| Endura Twist 2x2 | coarse 45% [G3] Filter | ePM1 75% [F7] Filter |
|--|---|---|
| Supplier's name or trademark | Renson Ventilation nv | Renson Ventilation nv |
| Reference model | Endura Twist 2x2, G3 [demand control] | Endura Twist 2x2, F7 [demand control] |
| Energy efficiency class* | A | A |
| SEC* - warm climat | -16,88 kWh/m ² a | -16,05 kWh/m ² a |
| SEC* - average climat | -40,96 kWh/m ² a | -40,13 kWh/m ² a |
| SEC* - cold climat | -82,99 kWh/m ² a | -82,16 kWh/m ² a |
| Declared typology | ZLA | ZLA |
| Type of drive installed | Variable speed | Variable speed |
| Type of heat recovery system | Regenerative | Regenerative |
| Thermal efficiency | 78% | 78% |
| Maximum flow rate | 48 m ³ /h | 39 m ³ /h |
| Electric power input of the fan drive, including any motor control equipment, at maximum flow rate | 10 W | 11 W |
| Sound power level L _{WA} | 47 dB[A] | 52 dB[A] |
| Reference flow rate | 34 m ³ /h | 27 m ³ /h |
| Reference pressure difference | 10 Pa | 10 Pa |
| SPI | 0,205 W/(m ³ /h) | 0,262 W/(m ³ /h) |
| Control typology | Local demand-driven setting | Local demand-driven setting |
| CTRL | 0,65 | 0,65 |
| Declared maximum internal leakage rates | Not applicable | Not applicable |
| Declared maximum external leakage rates | Not applicable | Not applicable |
| Recirculation | [1] | [1] |
| Mixing rate of non-ducted bidirectional ventilation units not intended to be equipped with one duct connection on either supply or extract air side | Not yet known | Not yet known |
| Position and description of visual filter warning for RVUs intended for use with filters, including text pointing out the importance of regular filter changes for performance and energy efficiency of the unit | Not applicable | Not applicable |
| Instructions to install regulated supply/exhaust grilles for natural air supply/extraction | www.renson.eu | www.renson.eu |
| Internet address for pre-/dis-assembly instructions | www.renson.eu | www.renson.eu |
| For non-ducted units only: the airflow sensitivity to pressure variations at + 20 Pa and - 20 Pa | < 5% von Q _{max} | < 5% von Q _{max} |
| For non-ducted units only: the indoor/outdoor air tightness in m ³ /h | Not yet known | Not yet known |
| AEC* [Annual Electricity Consumption] | 1,20 kWh electricity/m ² a | 1,53 kWh electricity/m ² a |
| AHS* [Annual Heat Saved] - cold climat | 85,97 kWh primary energy/m ² a | 85,97 kWh primary energy/m ² a |
| AHS* [Annual Heat Saved] - average climat | 43,95 kWh primary energy/m ² a | 43,95 kWh primary energy/m ² a |
| AHS* [Annual Heat Saved] - warm climat | 19,87 kWh primary energy/m ² a | 19,87 kWh primary energy/m ² a |

[1] Not available, method to be determined.

* with TouchDisplay

TECHNICAL DRAWINGS

Horizontal installation

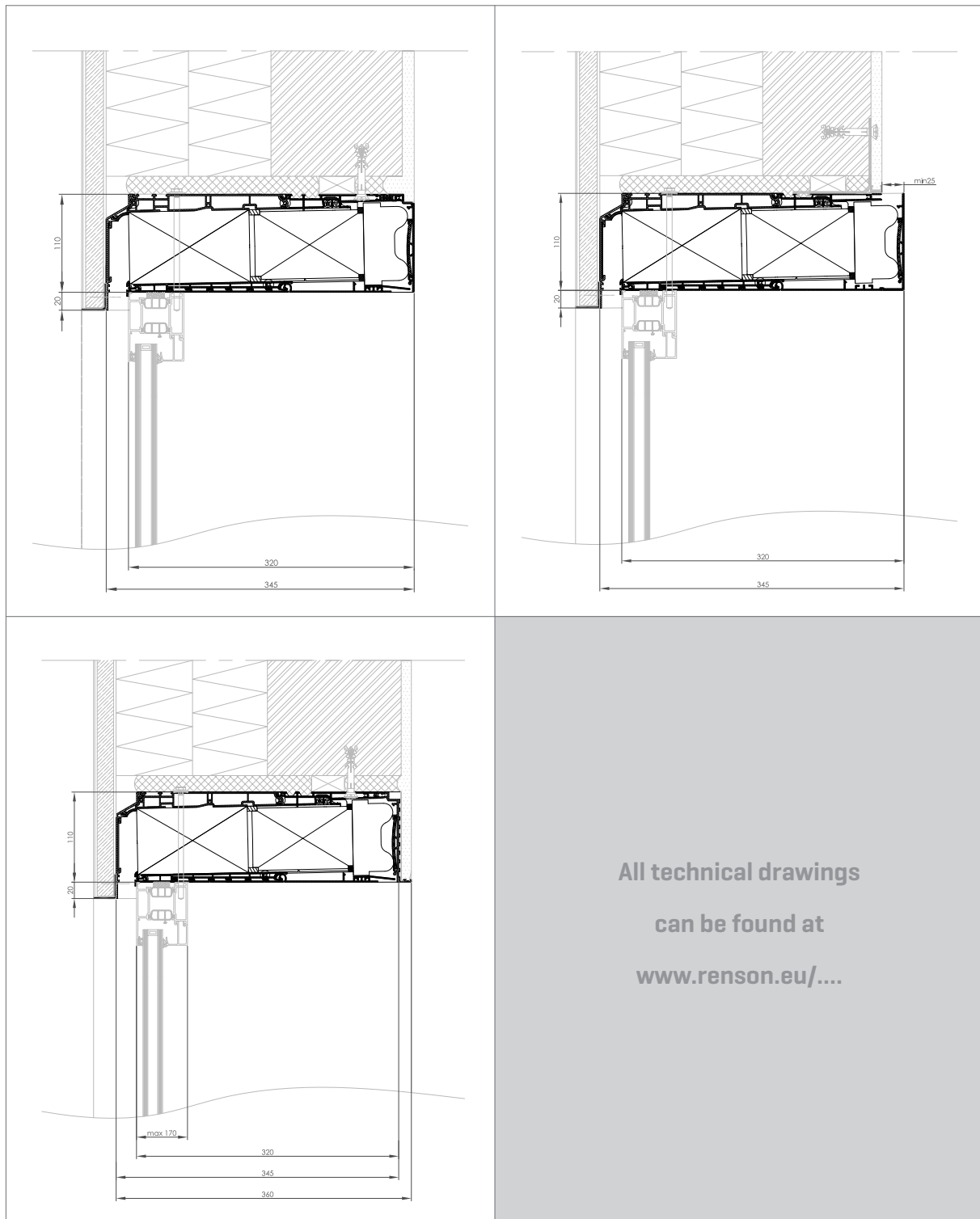

TECHNICAL DRAWINGS

Vertical installation

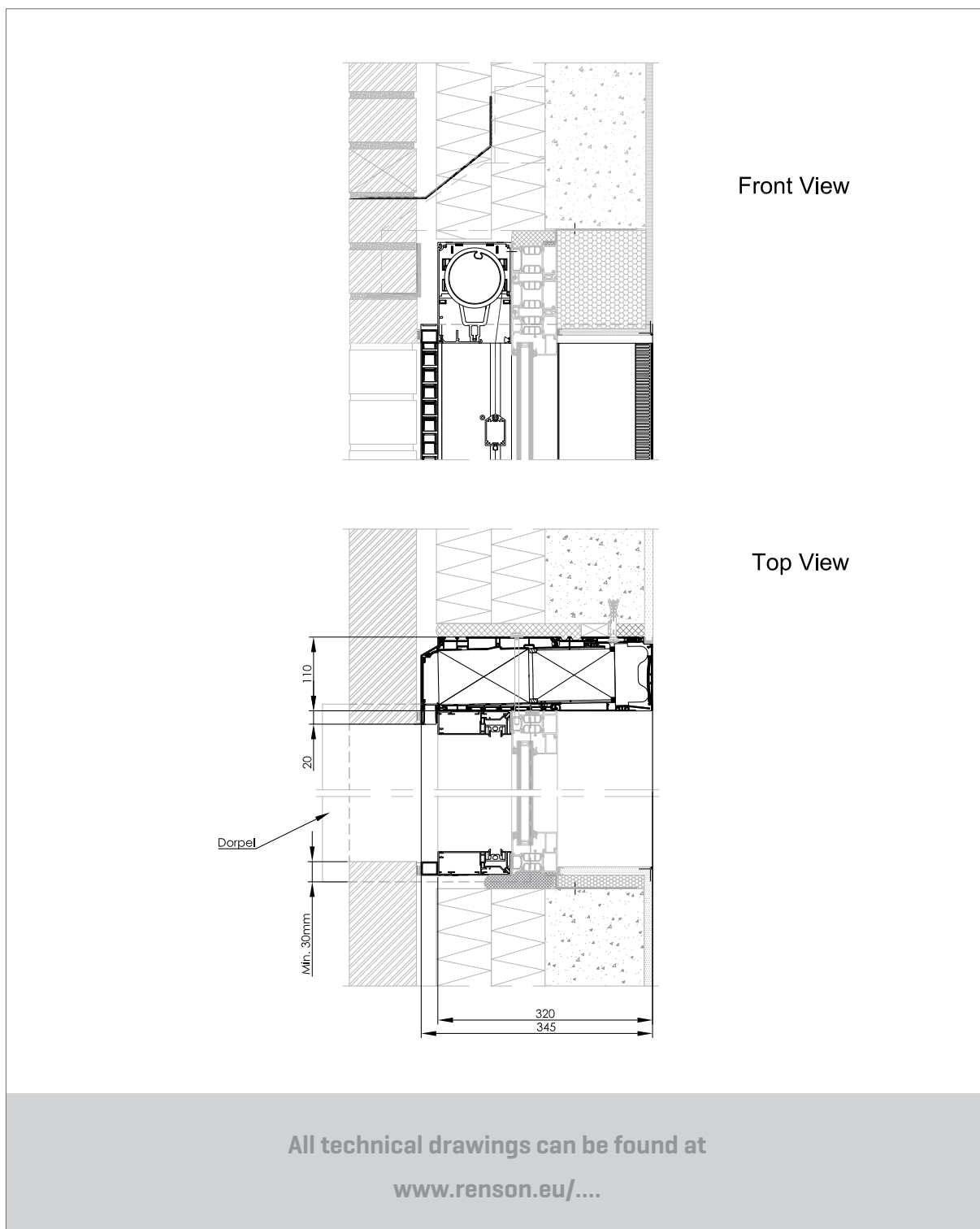

All technical drawings can be found at
www.renson.eu/...